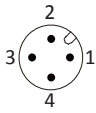

M18 SERIES

ARTICLE PROPERTIES

SENSOR TYPE	Inductive sensor	CONNECTION TYPES (see table)	
SIZE	M18x1	• cable	PVC, 0.34 mm ² , 2 m**
RATED OPERATING DISTANCE	see table	• M12 connector, A-coded	
NUMBER OF CONDUCTORS	2-wire / 3-wire / 4-wire (see table)		

** other cable lengths are available on request

MECHANICAL DATA

MOUNTING (mounting nuts included in delivery)	flush/non-flush (see table)
HOUSING	threaded cylindrical
MATERIAL HOUSING	brass nickel-plated
MATERIAL SENSING SURFACE	PBT
TIGHTENING TORQUE LOCKING	20 Nm
STANDARD TEST	FE360
ATTENUATION COEFFICIENT	St37 = 1, V2A = 0.7, Al = 0.3

ELECTRICAL DATA

OPERATING VOLTAGE	DC: 10 ... 30 V DC AC: 20 ... 250 V AC AC/DC: 20 ... 250 V AC/DC
RATED OPERATING CURRENT	2-wire DC: ≤ 100 mA 2-wire AC: ≤ 200 mA 3-wire: ≤ 200 mA 4-wire: ≤ 200 mA
SWITCHING FREQUENCY	see table
SWITCHING OUTPUT	see table
FUNCTION INDICATOR	yellow LED
HYSTERESIS	3 ... 15 %
TEMPERATURE DRIFT	±10 %
SHORT-CIRCUIT PROTECTION	yes
OVERLOAD RESISTANCE	yes
REVERSE POLARITY PROTECTION	yes

ENVIRONMENTAL CONDITIONS

PROTECTION CLASS	IP67	VIBRATION RESISTANCE (EN 60068-2-27)	55 Hz, 1 mm
AMBIENT TEMPERATURE	-25 ... 70 °C	SHOCK RESISTANCE (EN 60068-2-6)	30g/11 ms

STANDARDS AND DIRECTIVES

LOW-VOLTAGE SWITCHGEAR AND CONTROLGEAR	DIN EN IEC 60947-5-2:2021-04
---	------------------------------

APPROVALS



M18 SERIES

DC 2-WIRE OUTPUT CABLE

Article number	Mounting	Rated operating distance Sn	Switching output (wiring diagram)	Switching frequency	Dimensions
Fi5-M18-OD6L	flush	5 mm	DC NO (WD1)	800 Hz	see Fig. 1
Fi5-M18-CD6L	flush	5 mm	DC NC (WD2)	800 Hz	see Fig. 1
Ni8-M18-OD6L	non-flush	8 mm	DC NO (WD1)	500 Hz	see Fig. 2
Ni8-M18-CD6L	non-flush	8 mm	DC NC (WD2)	500 Hz	see Fig. 2

DC 2-WIRE OUTPUT M12 CONNECTOR

Article number	Mounting	Rated operating distance Sn	Switching output (wiring diagram)	Switching frequency	Dimensions
Fi5-M18-OD6L-Q12	flush	5 mm	DC NO (WD1)	800 Hz	see Fig. 7
Fi5-M18-CD6L-Q12	flush	5 mm	DC NC (WD2)	800 Hz	see Fig. 7
Ni8-M18-OD6L-Q12	non-flush	8 mm	DC NO (WD1)	500 Hz	see Fig. 8
Ni8-M18-CD6L-Q12	non-flush	8 mm	DC NC (WD2)	500 Hz	see Fig. 8

AC 2-WIRE OUTPUT CABLE

Article number	Mounting	Rated operating distance Sn	Switching output (wiring diagram)	Switching frequency	Dimensions
Fi5-M18-OSA3L	flush	5 mm	AC NO (WD3)	40 Hz	see Fig. 3
Fi5-M18-CSA3L	flush	5 mm	AC NC (WD4)	40 Hz	see Fig. 3
Ni8-M18-OSA3L	non-flush	8 mm	AC NO (WD3)	40 Hz	see Fig. 4
Ni8-M18-CSA3L	non-flush	8 mm	AC NC (WD4)	40 Hz	see Fig. 4

AC 2-WIRE OUTPUT M12 CONNECTOR

Article number	Mounting	Rated operating distance Sn	Switching output (wiring diagram)	Switching frequency	Dimensions
Fi5-M18-OSA3L-Q12	flush	5 mm	AC NO (WD3)	40 Hz	see Fig. 9
Fi5-M18-CSA3L-Q12	flush	5 mm	AC NC (WD4)	40 Hz	see Fig. 9
Ni8-M18-OSA3L-Q12	non-flush	8 mm	AC NO (WD3)	40 Hz	see Fig. 10
Ni8-M18-CSA3L-Q12	non-flush	8 mm	AC NC (WD4)	40 Hz	see Fig. 10

M18 SERIES

AC/DC 2-WIRE OUTPUT CABLE

Article number	Mounting	Rated operating distance Sn	Switching output (wiring diagram)	Switching frequency	Dimensions
Fi5-M18-OA41L	flush	5 mm	AC/DC NO (WD5)	40 Hz	see Fig. 3
Fi5-M18-CA41L	flush	5 mm	AC/DC NC (WD6)	40 Hz	see Fig. 3
Ni8-M18-OA41L	non-flush	8 mm	AC/DC NO (WD5)	40 Hz	see Fig. 4
Ni8-M18-CA41L	non-flush	8 mm	AC/DC NC (WD6)	40 Hz	see Fig. 4

AC/DC 2-WIRE OUTPUT M12 CONNECTOR

Article number	Mounting	Rated operating distance Sn	Switching output (wiring diagram)	Switching frequency	Dimensions
Fi5-M18-OA41L-Q12	flush	5 mm	AC/DC NO (WD5)	40 Hz	see Fig. 9
Fi5-M18-CA41L-Q12	flush	5 mm	AC/DC NC (WD6)	40 Hz	see Fig. 9
Ni8-M18-OA41L-Q12	non-flush	8 mm	AC/DC NO (WD5)	40 Hz	see Fig. 10
Ni8-M18-CA41L-Q12	non-flush	8 mm	AC/DC NC (WD6)	40 Hz	see Fig. 10

DC 3-WIRE OUTPUT CABLE

Article number	Mounting	Rated operating distance Sn	Switching output (wiring diagram)	Switching frequency	Dimensions
Fi5-M18-OP6L	flush	5 mm	PNP NO (WD7)	800 Hz	see Fig. 5
Fi5-M18-ON6L	flush	5 mm	NPN NO (WD8)	800 Hz	see Fig. 5
Fi5-M18-CP6L	flush	5 mm	PNP NC (WD9)	800 Hz	see Fig. 5
Fi5-M18-CN6L	flush	5 mm	NPN NC (WD10)	800 Hz	see Fig. 5
Ni8-M18-OP6L	non-flush	8 mm	PNP NO (WD7)	500 Hz	see Fig. 6
Ni8-M18-ON6L	non-flush	8 mm	NPN NO (WD8)	500 Hz	see Fig. 6
Ni8-M18-CP6L	non-flush	8 mm	PNP NC (WD9)	500 Hz	see Fig. 6
Ni8-M18-CN6L	non-flush	8 mm	NPN NC (WD10)	500 Hz	see Fig. 6

DC 3-WIRE OUTPUT M12 CONNECTOR

Article number	Mounting	Rated operating distance Sn	Switching output (wiring diagram)	Switching frequency	Dimensions
Fi5-M18-OP6L-Q12	flush	5 mm	PNP NO (WD7)	800 Hz	see Fig. 7
Fi5-M18-ON6L-Q12	flush	5 mm	NPN NO (WD8)	800 Hz	see Fig. 7
Fi5-M18-CP6L-Q12	flush	5 mm	PNP NC (WD9)	800 Hz	see Fig. 7
Fi5-M18-CN6L-Q12	flush	5 mm	NPN NC (WD10)	800 Hz	see Fig. 7
Ni8-M18-OP6L-Q12	non-flush	8 mm	PNP NO (WD7)	500 Hz	see Fig. 8
Ni8-M18-ON6L-Q12	non-flush	8 mm	NPN NO (WD8)	500 Hz	see Fig. 8
Ni8-M18-CP6L-Q12	non-flush	8 mm	PNP NC (WD9)	500 Hz	see Fig. 8
Ni8-M18-CN6L-Q12	non-flush	8 mm	NPN NC (WD10)	500 Hz	see Fig. 8

M18 SERIES

DC 4-WIRE OUTPUT CABLE

Article number	Mounting	Rated operating distance Sn	Switching output (wiring diagram)	Switching frequency	Dimensions
Fi5-M18-BP6L	flush	5 mm	PNP NO+NC (WD11)	800 Hz	<i>see Fig. 5</i>
Fi5-M18-BN6L	flush	5 mm	NPN NO+NC (WD12)	800 Hz	<i>see Fig. 5</i>
Ni8-M18-BP6L	non-flush	8 mm	PNP NO+NC (WD11)	500 Hz	<i>see Fig. 6</i>
Ni8-M18-BN6L	non-flush	8 mm	NPN NO+NC (WD12)	500 Hz	<i>see Fig. 6</i>

DC 4-WIRE OUTPUT M12 CONNECTOR

Article number	Mounting	Rated operating distance Sn	Switching output (wiring diagram)	Switching frequency	Dimensions
Fi5-M18-BP6L-Q12	flush	5 mm	PNP NO+NC (WD11)	800 Hz	<i>see Fig. 7</i>
Fi5-M18-BN6L-Q12	flush	5 mm	NPN NO+NC (WD12)	800 Hz	<i>see Fig. 7</i>
Ni8-M18-BP6L-Q12	non-flush	8 mm	PNP NO+NC (WD11)	500 Hz	<i>see Fig. 8</i>
Ni8-M18-BN6L-Q12	non-flush	8 mm	NPN NO+NC (WD12)	500 Hz	<i>see Fig. 8</i>

M18 SERIES

DIMENSIONS

Fig. 1 Inductive sensor with cable (flush)

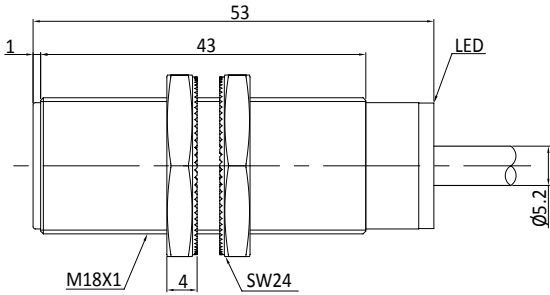

Fig. 2 Inductive sensor with cable (non-flush)

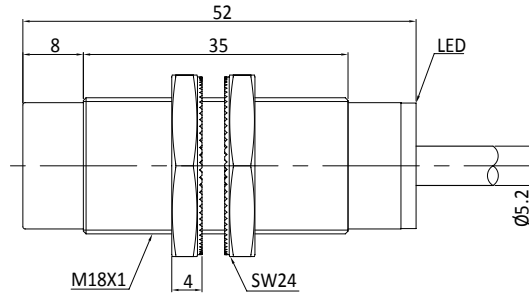

Fig. 3 Inductive sensor with cable (flush)

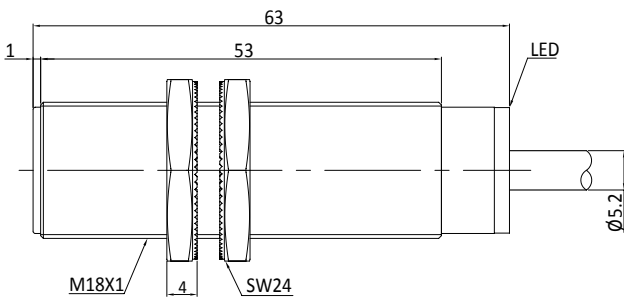

Fig. 4 Inductive sensor with cable (non-flush)

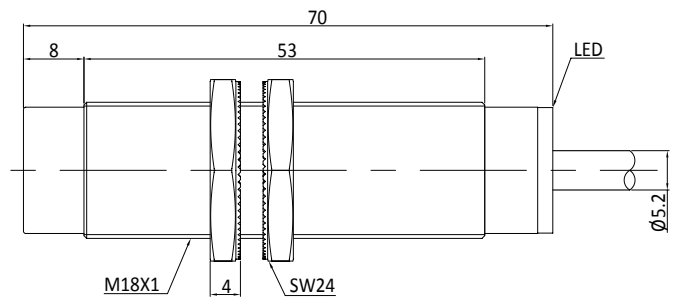

Fig. 5 Inductive sensor with cable (flush)

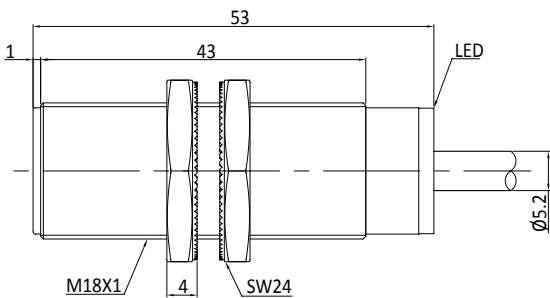
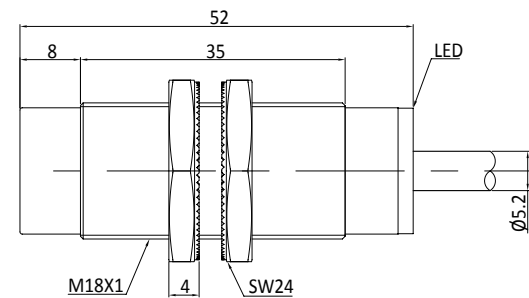

Fig. 6 Inductive sensor with cable (non-flush)



M18 SERIES

DIMENSIONS

Fig. 7 Inductive sensor with M12 connector (flush)

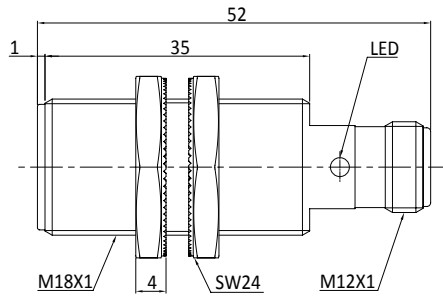

Fig. 8 Inductive sensor with M12 connector (non-flush)

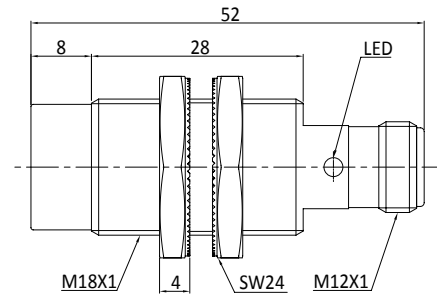

Fig. 9 Inductive sensor with M12 connector (flush)

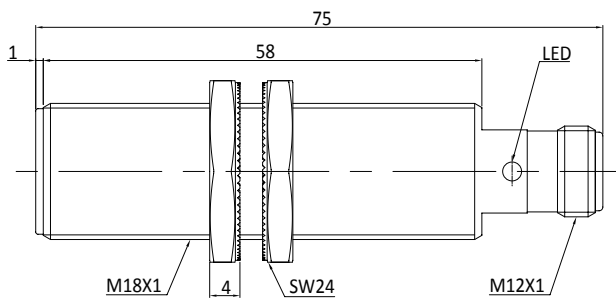
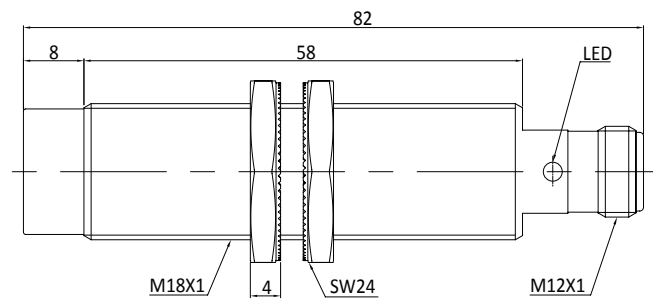

Fig. 10 Inductive sensor with M12 connector (non-flush)



M18 SERIES

WIRING DIAGRAMS (Note: 1 / 2 / 3 / 4 connector and terminals pin number Bn / Bu / Wh / Bk cable color)

WD1 DC 2-wire NO

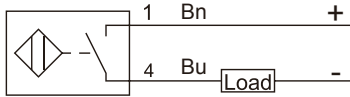

WD2 DC 2-wire NC

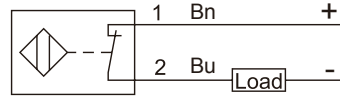

WD3 AC 2-wire NO

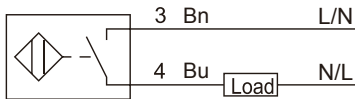

WD4 AC 2-wire NC

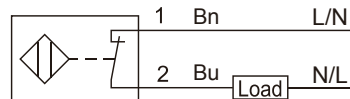

WD5 AC / DC 2-wire NO

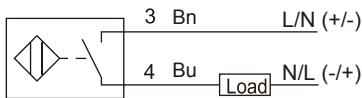

WD6 AC / DC 2-wire NC

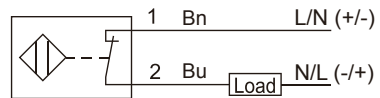

WD7 DC 3-wire PNP NO

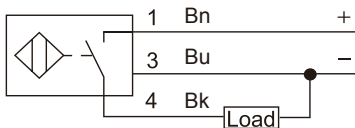

WD8 DC 3-wire NPN NO

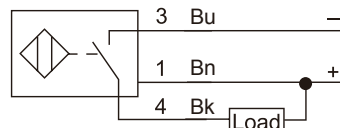

WD9 DC 3-wire PNP NC

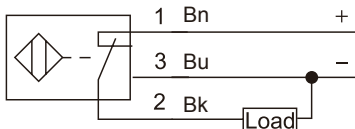

WD10 DC 3-wire NPN NC

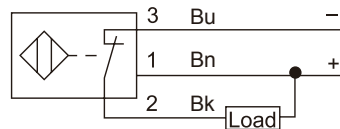

WD11 DC 4-wire PNP NO + NC

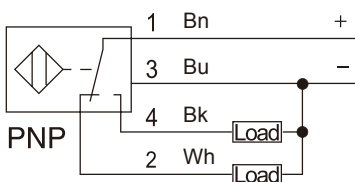

WD12 DC 4-wire NPN NO + NC

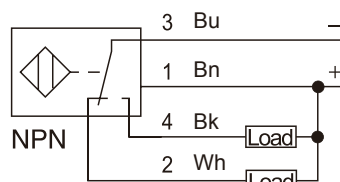

M18 SERIES

WIRING DIAGRAMS (Note: 1 / 2 / 3 / 4 connector and terminals pin number Bn / Bu / Wh / Bk cable color)

WD13 AC/DC 4-wire NO+NC

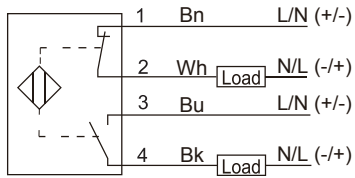

WD14 NAMUR 2-wire NC

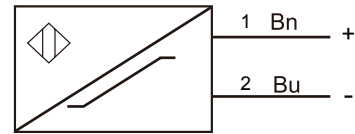

WD15 DC 4-wire 0-10V+0-20mA

