

## Q25 PLASTIC RECTANGULAR SERIES

## ARTICLE PROPERTIES

<b>SENSOR TYPE</b>	Inductive sensor	<b>CONNECTION TYPES</b> (see table)	
<b>SIZE</b>	25 x 25 x 38 mm	• cable	PVC, 0.34 mm <sup>2</sup> , 2 m**
<b>RATED OPERATING DISTANCE</b>	see table		
<b>NUMBER OF CONDUCTORS</b>	2-wire / 3-wire (see table)		** other cable lengths are available on request

## MECHANICAL DATA

<b>MOUNTING</b> (mounting nuts included in delivery)	flush/non-flush (see table)
<b>HOUSING</b>	rectangular
<b>MATERIAL HOUSING</b>	PBT
<b>MATERIAL SENSING SURFACE</b>	PBT
<b>TIGHTENING TORQUE LOCKING</b>	1 Nm
<b>STANDARD TEST</b>	FE360
<b>ATTENUATION COEFFICIENT</b>	St37 = 1, V2A = 0.7, Al = 0.3

## ELECTRICAL DATA

<b>OPERATING VOLTAGE</b>	DC: 10 ... 30 V DC AC: 20 ... 250 V AC AC/DC: 20 ... 250 V AC/DC
<b>RATED OPERATING CURRENT</b>	2-wire DC: ≤ 100 mA 2-wire AC: ≤ 200 mA 3-wire: ≤ 200 mA
<b>SWITCHING FREQUENCY</b>	see table
<b>SWITCHING OUTPUT</b>	see table
<b>FUNCTION INDICATOR</b>	yellow LED
<b>HYSTERESIS</b>	3 ... 15 %
<b>TEMPERATURE DRIFT</b>	±10 %
<b>SHORT-CIRCUIT PROTECTION</b>	yes
<b>OVERLOAD RESISTANCE</b>	yes
<b>REVERSE POLARITY PROTECTION</b>	yes

## ENVIRONMENTAL CONDITIONS

<b>PROTECTION CLASS</b>	IP67	<b>VIBRATION RESISTANCE</b> (EN 60068-2-27)	55 Hz, 1 mm
<b>AMBIENT TEMPERATURE</b>	-25 ... 70 °C	<b>SHOCK RESISTANCE</b> (EN 60068-2-6)	30g/11 ms

## STANDARDS AND DIRECTIVES

<b>LOW-VOLTAGE SWITCHGEAR AND CONTROLGEAR</b>	DIN EN IEC 60947-5-2:2021-04
---	------------------------------

## APPROVALS



## Q25 PLASTIC RECTANGULAR SERIES

## DC 2-WIRE OUTPUT CABLE

Article number	Mounting	Rated operating distance Sn	Switching output (wiring diagram)	Switching frequency	Dimensions
Fi7-Q25-OD6L	flush	7 mm	DC NO (WD1)	200 Hz	see Fig. 1
Fi7-Q25-CD6L	flush	7 mm	DC NC (WD2)	200 Hz	see Fig. 1
Ni10-Q25-OD6L	non-flush	10 mm	DC NO (WD1)	200 Hz	see Fig. 1
Ni10-Q25-CD6L	non-flush	10 mm	DC NC (WD2)	200 Hz	see Fig. 1

## AC 2-WIRE OUTPUT CABLE

Article number	Mounting	Rated operating distance Sn	Switching output (wiring diagram)	Switching frequency	Dimensions
Fi7-Q25-OSA3L	flush	7 mm	AC NO (WD3)	300 Hz	see Fig. 1
Fi7-Q25-CSA3L	flush	7 mm	AC NC (WD4)	300 Hz	see Fig. 1
Ni10-Q25-OSA3L	non-flush	10 mm	AC NO (WD3)	300 Hz	see Fig. 1
Ni10-Q25-CSA3L	non-flush	10 mm	AC NC (WD4)	300 Hz	see Fig. 1

## AC/DC 2-WIRE OUTPUT CABLE

Article number	Mounting	Rated operating distance Sn	Switching output (wiring diagram)	Switching frequency	Dimensions
Fi7-Q25-OA41L	flush	7 mm	AC/DC NO (WD5)	300 Hz	see Fig. 1
Fi7-Q25-CA41L	flush	7 mm	AC/DC NC (WD6)	300 Hz	see Fig. 1
Ni10-Q25-OA41L	non-flush	10 mm	AC/DC NO (WD5)	300 Hz	see Fig. 1
Ni10-Q25-CA41L	non-flush	10 mm	AC/DC NC (WD6)	300 Hz	see Fig. 1

## DC 3-WIRE OUTPUT CABLE

Article number	Mounting	Rated operating distance Sn	Switching output (wiring diagram)	Switching frequency	Dimensions
Fi7-Q25-OP6L	flush	7 mm	PNP NO (WD7)	700 Hz	see Fig. 1
Fi7-Q25-ON6L	flush	7 mm	NPN NO (WD8)	700 Hz	see Fig. 1
Fi7-Q25-CP6L	flush	7 mm	PNP NC (WD9)	700 Hz	see Fig. 1
Fi7-Q25-CN6L	flush	7 mm	NPN NC (WD10)	700 Hz	see Fig. 1
Ni10-Q25-OP6L	non-flush	10 mm	PNP NO (WD7)	700 Hz	see Fig. 1
Ni10-Q25-ON6L	non-flush	10 mm	NPN NO (WD8)	700 Hz	see Fig. 1
Ni10-Q25-CP6L	non-flush	10 mm	PNP NC (WD9)	700 Hz	see Fig. 1
Ni10-Q25-CN6L	non-flush	10 mm	NPN NC (WD10)	700 Hz	see Fig. 1

Q25 PLASTIC RECTANGULAR SERIES

DIMENSIONS

Fig. 1 Inductive sensor with cable (flush/non-flush)

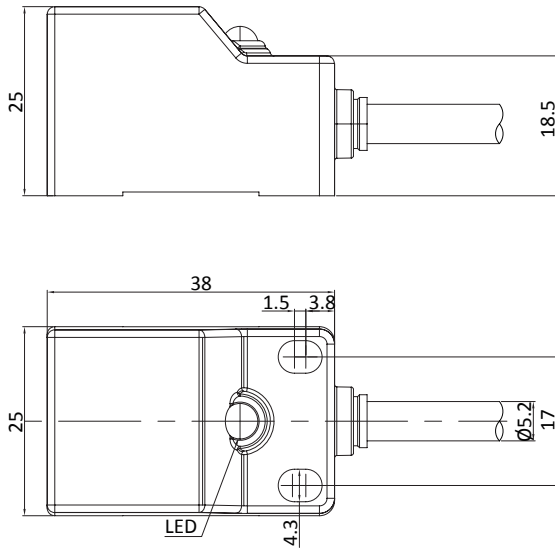

Q25 PLASTIC RECTANGULAR SERIES

WIRING DIAGRAMS (Note: 1 / 2 / 3 / 4 connector and terminals pin number Bn / Bu / Wh / Bk cable color)

WD1 DC 2-wire NO

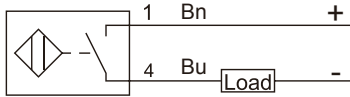

WD2 DC 2-wire NC

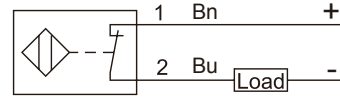

WD3 AC 2-wire NO

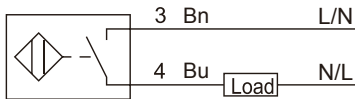

WD4 AC 2-wire NC

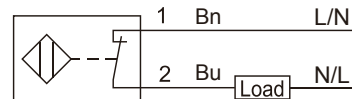

WD5 AC / DC 2-wire NO

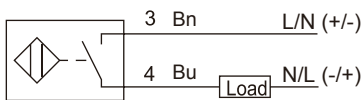

WD6 AC / DC 2-wire NC

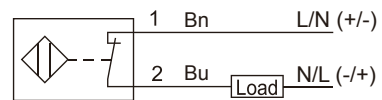

WD7 DC 3-wire PNP NO

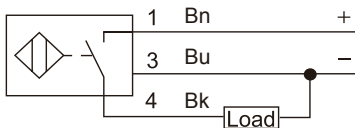

WD8 DC 3-wire NPN NO

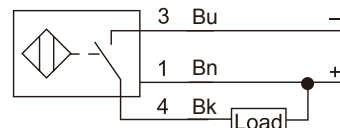

WD9 DC 3-wire PNP NC

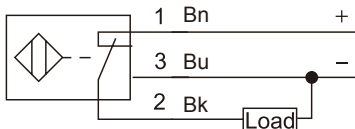

WD10 DC 3-wire NPN NC

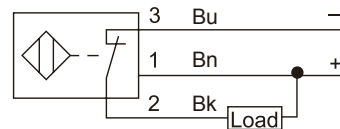

WD11 DC 4-wire PNP NO + NC

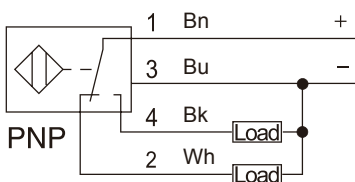

WD12 DC 4-wire NPN NO + NC

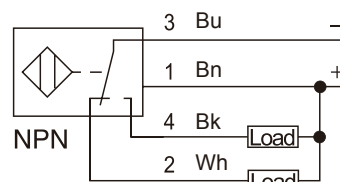

Q25 PLASTIC RECTANGULAR SERIES

WIRING DIAGRAMS (Note: 1 / 2 / 3 / 4 connector and terminals pin number Bn / Bu / Wh / Bk cable color)

**WD13 AC/DC 4-wire NO+NC**

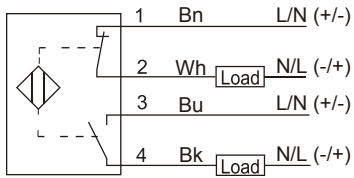

**WD14 NAMUR 2-wire NC**

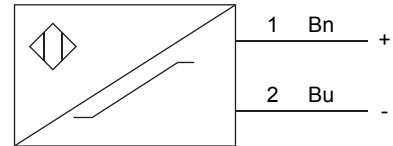

**WD15 DC 4-wire 0-10V+0-20mA**

