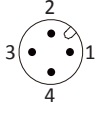

M18 LOW TEMPERATURE SERIES

ARTICLE PROPERTIES

<b>SENSOR TYPE</b>	Inductive sensor	<b>CONNECTION TYPES</b> ( <i>see table</i> )
<b>SIZE</b>	M18x1	<ul style="list-style-type: none"> <li>• cable PTFE, 0.34 mm<sup>2</sup>, 2 m**</li> <li>• M12 connector, A-coded</li> </ul>
<b>RATED OPERATING DISTANCE</b>	<i>see table</i>	
<b>NUMBER OF CONDUCTORS</b>	2-wire / 3-wire ( <i>see table</i> )	

\*\* other cable lengths are available on request

MECHANICAL DATA

<b>MOUNTING</b> (mounting nuts included in delivery)	flush/non-flush ( <i>see table</i> )
<b>HOUSING</b>	threaded cylindrical
<b>MATERIAL HOUSING</b>	brass nickel-plated
<b>MATERIAL SENSING SURFACE</b>	PBT
<b>TIGHTENING TORQUE LOCKING</b>	20 Nm
<b>STANDARD TEST</b>	FE360
<b>ATTENUATION COEFFICIENT</b>	St37 = 1, V2A = 0.7, Al = 0.3

ELECTRICAL DATA

<b>OPERATING VOLTAGE</b>	DC: 10 ... 30 V DC AC/DC: 20 ... 250 V AC/DC
<b>RATED OPERATING CURRENT</b>	2-wire: ≤ 100 mA 2-wire AC: ≤ 200 mA 3-wire: ≤ 200 mA
<b>SWITCHING FREQUENCY</b>	<i>see table</i>
<b>SWITCHING OUTPUT</b>	<i>see table</i>
<b>FUNCTION INDICATOR</b>	yellow LED
<b>HYSTERESIS</b>	3 ... 15 %
<b>TEMPERATURE DRIFT</b>	±10 %
<b>SHORT-CIRCUIT PROTECTION</b>	yes
<b>OVERLOAD RESISTANCE</b>	yes
<b>REVERSE POLARITY PROTECTION</b>	yes

ENVIRONMENTAL CONDITIONS

<b>PROTECTION CLASS</b>	IP67	<b>VIBRATION RESISTANCE (EN 60068-2-27)</b>	55 Hz, 1 mm
<b>AMBIENT TEMPERATURE</b>	-40 ... 70 °C	<b>SHOCK RESISTANCE (EN 60068-2-6)</b>	30g/11 ms

STANDARDS AND DIRECTIVES

<b>LOW-VOLTAGE SWITCHGEAR AND CONTROLGEAR</b>	DIN EN IEC 60947-5-2:2021-04
---	------------------------------

APPROVALS



## M18 LOW TEMPERATURE SERIES

## DC 2-WIRE OUTPUT CABLE

Article number	Mounting	Rated operating distance Sn	Switching output (wiring diagram)	Switching frequency	Dimensions
Fi5-M18-OD6L/TB40	flush	5 mm	DC NO (WD1)	800 Hz	see Fig. 1
Fi5-M18-CD6L/TB40	flush	5 mm	DC NC (WD2)	800 Hz	see Fig. 1
Ni8-M18-OD6L/TB40	non-flush	8 mm	DC NO (WD1)	500 Hz	see Fig. 2
Ni8-M18-CD6L/TB40	non-flush	8 mm	DC NC (WD2)	500 Hz	see Fig. 2

## DC 2-WIRE OUTPUT M12 CONNECTOR

Article number	Mounting	Rated operating distance Sn	Switching output (wiring diagram)	Switching frequency	Dimensions
Fi5-M18-OD6L-Q12/TB40	flush	5 mm	DC NO (WD1)	800 Hz	see Fig. 6
Fi5-M18-CD6L-Q12/TB40	flush	5 mm	DC NC (WD2)	800 Hz	see Fig. 6
Ni8-M18-OD6L-Q12/TB40	non-flush	8 mm	DC NO (WD1)	500 Hz	see Fig. 7
Ni8-M18-CD6L-Q12/TB40	non-flush	8 mm	DC NC (WD2)	500 Hz	see Fig. 7

## AC/DC 2-WIRE OUTPUT CABLE

Article number	Mounting	Rated operating distance Sn	Switching output (wiring diagram)	Switching frequency	Dimensions
Fi5-M18-OA41L/TB40	flush	5 mm	AC/DC NO (WD5)	40 Hz	see Fig. 4
Fi5-M18-CA41L/TB40	flush	5 mm	AC/DC NC (WD6)	40 Hz	see Fig. 4
Ni8-M18-OA41L/TB40	non-flush	8 mm	AC/DC NO (WD5)	40 Hz	see Fig. 5
Ni8-M18-CA41L/TB40	non-flush	8 mm	AC/DC NC (WD6)	40 Hz	see Fig. 5

## AC/DC 2-WIRE OUTPUT M12 CONNECTOR

Article number	Mounting	Rated operating distance Sn	Switching output (wiring diagram)	Switching frequency	Dimensions
Fi5-M18-OA41L-Q12/TB40	flush	5 mm	AC/DC NO (WD5)	40 Hz	see Fig. 8
Fi5-M18-CA41L-Q12/TB40	flush	5 mm	AC/DC NC (WD6)	40 Hz	see Fig. 8
Ni8-M18-OA41L-Q12/TB40	non-flush	8 mm	AC/DC NO (WD5)	40 Hz	see Fig. 9
Ni8-M18-CA41L-Q12/TB40	non-flush	8 mm	AC/DC NC (WD6)	40 Hz	see Fig. 9

## M18 LOW TEMPERATURE SERIES

## DC 3-WIRE OUTPUT CABLE

Article number	Mounting	Rated operating distance Sn	Switching output (wiring diagram)	Switching frequency	Dimensions
Fi5-M18-OP6L/TB40	flush	5 mm	PNP NO (WD7)	800 Hz	see Fig. 1
Fi5-M18-ON6L/TB40	flush	5 mm	NPN NO (WD8)	800 Hz	see Fig. 1
Fi5-M18-CP6L/TB40	flush	5 mm	PNP NC (WD9)	800 Hz	see Fig. 1
Fi5-M18-CN6L/TB40	flush	5 mm	NPN NC (WD10)	800 Hz	see Fig. 1
Ni8-M18-OP6L/TB40	non-flush	8 mm	PNP NO (WD7)	500 Hz	see Fig. 3
Ni8-M18-ON6L/TB40	non-flush	8 mm	NPN NO (WD8)	500 Hz	see Fig. 3
Ni8-M18-CP6L/TB40	non-flush	8 mm	PNP NC (WD9)	500 Hz	see Fig. 3
Ni8-M18-CN6L/TB40	non-flush	8 mm	NPN NC (WD10)	500 Hz	see Fig. 3

## DC 3-WIRE OUTPUT M12 CONNECTOR

Article number	Mounting	Rated operating distance Sn	Switching output (wiring diagram)	Switching frequency	Dimensions
Fi5-M18-OP6L-Q12/TB40	flush	5 mm	PNP NO (WD7)	800 Hz	see Fig. 6
Fi5-M18-ON6L-Q12/TB40	flush	5 mm	NPN NO (WD8)	800 Hz	see Fig. 6
Fi5-M18-CP6L-Q12/TB40	flush	5 mm	PNP NC (WD9)	800 Hz	see Fig. 6
Fi5-M18-CN6L-Q12/TB40	flush	5 mm	NPN NC (WD10)	800 Hz	see Fig. 6
Ni8-M18-OP6L-Q12/TB40	non-flush	8 mm	PNP NO (WD7)	500 Hz	see Fig. 7
Ni8-M18-ON6L-Q12/TB40	non-flush	8 mm	NPN NO (WD8)	500 Hz	see Fig. 7
Ni8-M18-CP6L-Q12/TB40	non-flush	8 mm	PNP NC (WD9)	500 Hz	see Fig. 7
Ni8-M18-CN6L-Q12/TB40	non-flush	8 mm	NPN NC (WD10)	500 Hz	see Fig. 7

M18 LOW TEMPERATURE SERIES

DIMENSIONS

Fig. 1 Inductive sensor with cable (flush)

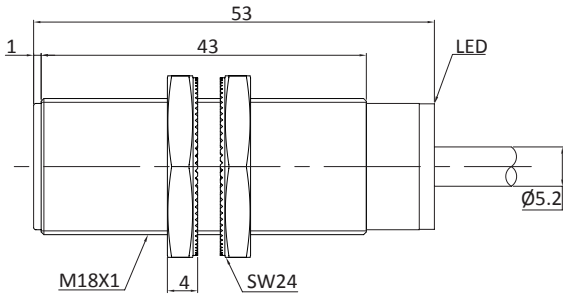

Fig. 2 Inductive sensor with cable (non-flush)

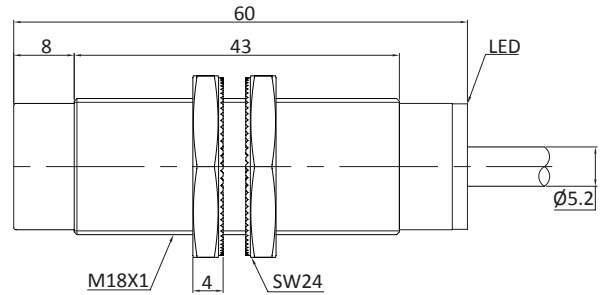

Fig. 3 Inductive sensor with cable (non-flush)

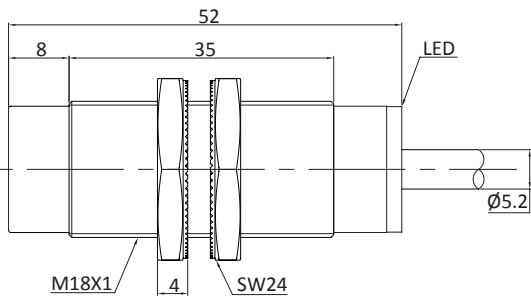

Fig. 4 Inductive sensor with cable (flush)

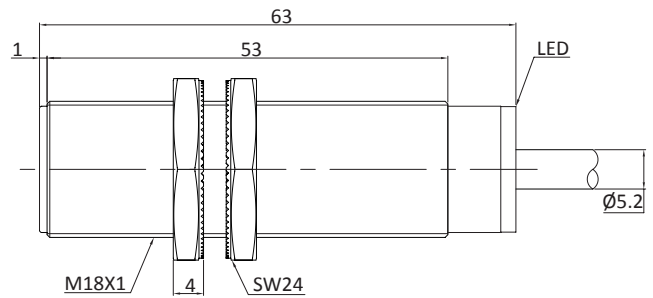

Fig. 5 Inductive sensor with cable (non-flush)

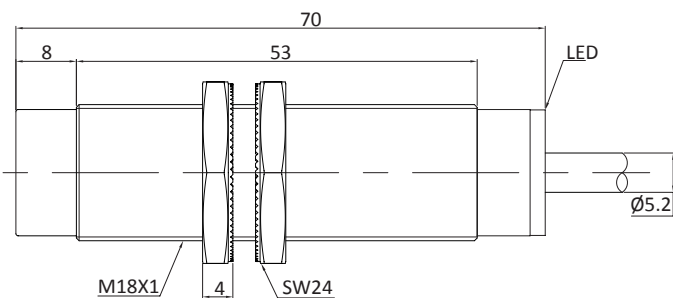

Fig. 6 Inductive sensor with M12 connector (flush)

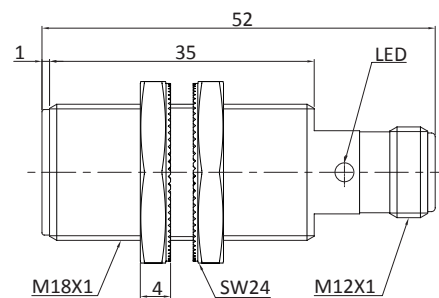

Fig. 7 Inductive sensor with M12 connector (non-flush)

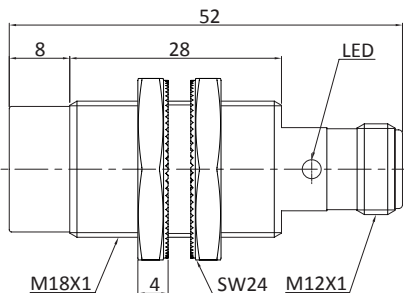
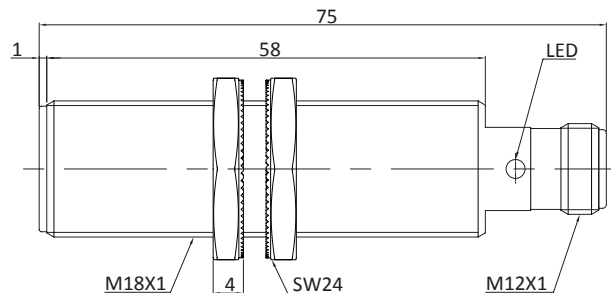

Fig. 8 Inductive sensor with M12 connector (flush)



M18 LOW TEMPERATURE SERIES

DIMENSIONS

**Fig. 9** Inductive sensor with M12 connector (non-flush)

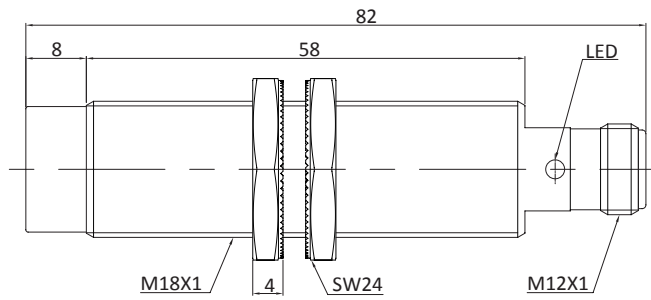

M18 LOW TEMPERATURE SERIES

WIRING DIAGRAMS (Note: 1 / 2 / 3 / 4 connector and terminals pin number Bn / Bu / Wh / Bk cable color)

**WD1 DC 2-wire NO**

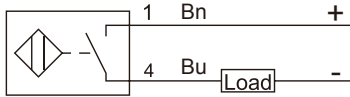

**WD2 DC 2-wire NC**

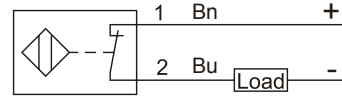

**WD3 AC 2-wire NO**

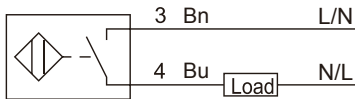

**WD4 AC 2-wire NC**

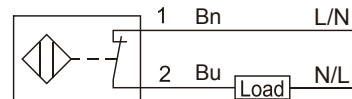

**WD5 AC / DC 2-wire NO**

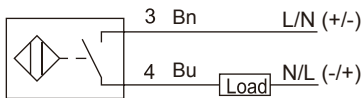

**WD6 AC / DC 2-wire NC**

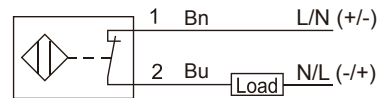

**WD7 DC 3-wire PNP NO**

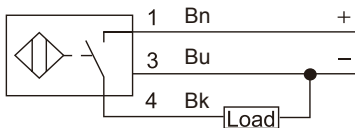

**WD8 DC 3-wire NPN NO**

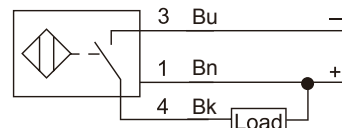

**WD9 DC 3-wire PNP NC**

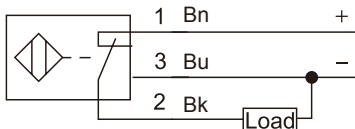

**WD10 DC 3-wire NPN NC**

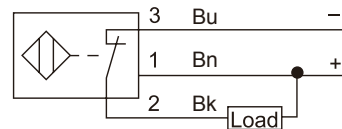

**WD11 DC 4-wire PNP NO + NC**

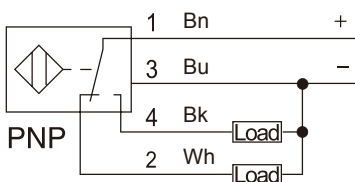

**WD12 DC 4-wire NPN NO + NC**

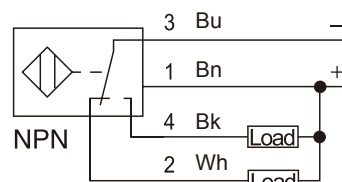

M18 LOW TEMPERATURE SERIES

WIRING DIAGRAMS (Note: 1 / 2 / 3 / 4 connector and terminals pin number Bn / Bu / Wh / Bk cable color)

**WD13 AC/DC 4-wire NO+NC**

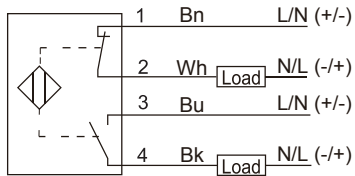

**WD14 NAMUR 2-wire NC**

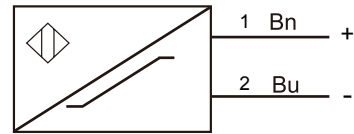

**WD15 DC 4-wire 0-10V+0-20mA**

